

# SERIES YK531

FULL BORE  
1000WOG  
1/4"-4"

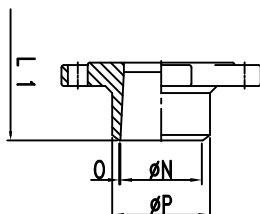
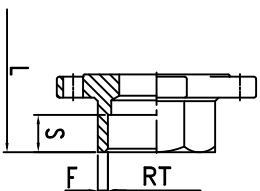
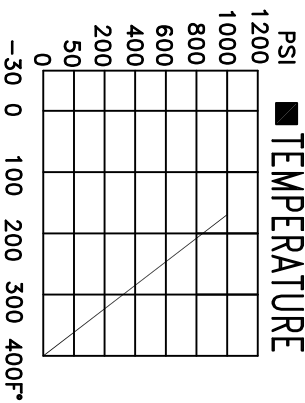
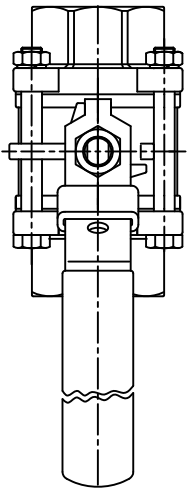
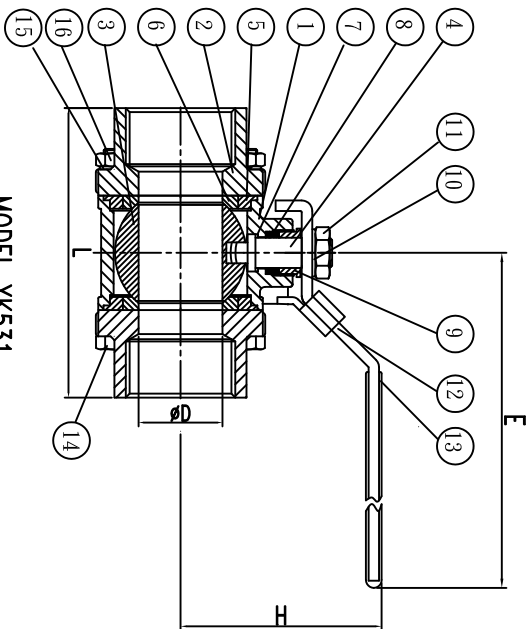

MODEL YK531S  
Socket Weld  
End

MODEL YK531B  
Butt Weld  
End

## ■ MATERIALS LIST

NO.	PART NAME	QTY	MATERIAL
1	BODY	1	ASTM-A216-WCB
2	BODY CAP	2	ASTM-A216-WCB
3	BALL	1	ASTM-CF8M-A351
4	STEM	1	AISI 316
5	JOINT GASKET	2	PTFE
6	SEAT	2	PTFE
7	THRUST WASHER	1	PTFE
8	STEM PACKING	1	PTFE
9	GLAND NUT	1	AISI 304
10	STEM WASHER	1	AISI 304
11	STEM NUT	1	AISI 304
12	HANDLE	1	AISI 304
13	COVER	1	PLASTIC
14	BOLT	*	AISI 304
15	BOLT WASHER	*	AISI 304
16	HEX NUT	*	AISI 304

## ■ DIMENSIONS(INCH)

SIZE	Ø D	E	F	H	S	L	L1	Ø N	O	Ø P	RT
1/4"	0.46	4.04	0.14	2.13	0.43	2.36	2.4	0.47	0.04	0.71	0.57
3/8"	0.49	4.04	0.08	2.13	0.43	2.36	2.4	0.55	0.04	0.71	0.7
1/2"	0.59	5.24	0.08	2.17	0.47	2.72	2.72	0.67	0.04	0.87	0.85
3/4"	0.79	5.24	0.1	2.32	0.55	3.07	3.07	0.89	0.04	1.08	1.07
1"	0.98	6.02	0.13	2.76	0.55	3.31	3.31	1.02	0.04	1.32	1.34
1 1/4"	1.26	6.02	0.16	2.95	0.59	4.09	4.09	1.38	0.04	1.73	1.69
1 1/2"	1.5	7.52	0.15	3.27	0.67	4.69	4.69	1.63	0.04	1.97	1.93
2"	1.97	7.52	0.17	3.58	0.75	5.16	5.16	2.09	0.04	2.42	2.42
2 1/2"	2.56	9.72	0.23	5.04	0.83	6.38	6.38	2.56	0.04	2.99	2.91
3"	3.15	9.72	0.21	5.39	0.98	7.17	7.17	3.15	0.04	3.62	3.54
4"	3.94	11.61	0.22	6.85	1.18	9.06	9.06	3.94	0.04	4.53	4.57

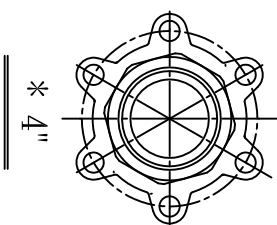
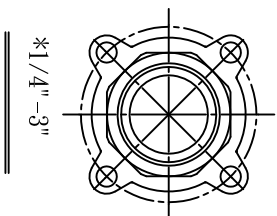

修正 REVISION	日期 DATE	說明 DESCRIPTION	繪圖 DRAWN BY	設計 DESIGNED BY	比例尺 SCALE
△	99-05-13	螺栓方向修改	PETER	PETER	
△	105-05-11	刪除 YK531LB	核對 CHECKED BY	核准 APPROVAL BY	日期 DATE
					94-09-19

J&M INTERNATIONAL LTD

SERIES YK531  
DRAWING NO. 3015WCB